

COMPLIANCE INFORMATION

UL Listed
C-UL Listed (Canada)
CISPR/EN55022 Class A

FCC Regulations

This equipment has been tested and found to comply with the limits for a class A digital device, pursuant to part 15 of the FCC rules. These limits are designed to provide reasonable protection against harmful interference when the equipment is operated in a commercial environment. This equipment generates, uses, and can radiate radio frequency energy and, if not installed and used in accordance with the instruction manual, may cause harmful interference to radio communications. Operation of this equipment in a residential area is likely to cause harmful interference, in which case the user will be required to correct the interference at the user's own expense.

Canadian Regulations

This digital apparatus does not exceed the Class A limits for radio noise for digital apparatus set out on the radio interference regulations of the Canadian Department of Communications.

Le présent appareil numérique n'émet pas de bruits radioélectriques dépassant les limites applicables aux appareils numériques de la class A prescrites dans le Règlement sur le brouillage radioélectrique édicté par le ministère des Communications du Canada.

European Regulations

Warning

This is a Class A product. In a domestic environment this product may cause radio interference in which case the user may be required to take adequate measures.

Achtung !

Dieses ist ein Gerät der Funkstörgrenzwertklasse A. In Wohnbereichen können bei Betrieb dieses Gerätes Rundfunkstörungen auftreten, in welchen Fällen der Benutzer für entsprechende Gegenmaßnahmen verantwortlich ist.

Attention !

Ceci est un produit de Classe A. Dans un environnement domestique, ce produit risque de créer des interférences radioélectriques, il appartiendra alors à l'utilisateur de prendre les mesures spécifiques appropriées



CAUTION: RJ connectors are NOT INTENDED FOR CONNECTION TO THE PUBLIC TELEPHONE NETWORK. Failure to observe this caution could result in damage to the public telephone network.

Der Anschluss dieses Gerätes an ein öffentliches Telekommunikationsnetz in den EG-Mitgliedstaaten verstößt gegen die jeweiligen einzelstaatlichen Gesetze zur Anwendung der Richtlinie 91/263/EWG zur Angleichung der Rechtsvorschriften der Mitgliedstaaten über Telekommunikationsendeinrichtungen einschliesslich der gegenseitigen Anerkennung ihrer Konformität.

Trademark Notice

All registered trademarks and trademarks are the property of their respective owners.

Copyright Restrictions

© 1999-2001 TRANSITION Networks.
All rights reserved. No part of this work may be reproduced or used in any form or by any means – graphic, electronic, or mechanical – without written permission from TRANSITION Networks.

Printed in the U.S.A.

33101.D

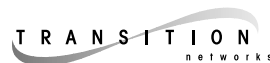

10BASE-T/100BASE-TX to 100BASE-FX

Bridging Media Converter

E-PSW-FX-03, E-PSW-FX-03(SC), E-PSW-FX-03(SM)
E-PSW-FX-03(LH), E-PSW-FX-03(XL), E-PSW-FX-03(LW)

USER'S GUIDE

TRANSITION Networks E-PSW-FX-03 series two-port bridging media converter, designed to be installed in the TRANSITION Networks Media Conversion Center, E-MCC-1600, segments 10BASE-T/100BASE-TX copper and 100BASE-FX fiber Ethernet™ collision domains to allow the network administrator to extend the total network diameter, to reduce network congestion, and/or to convert between legacy 10BASE-T and 100BASE-FX environments.

E-PSW-FX-03

*Provides an RJ-45 twisted-pair connector to UTP/STP copper cable and a set of RX (receive) and TX (transmit) **ST 1300nm multimode** fiber connectors.*

E-PSW-FX-03(SC)

*Provides an RJ-45 twisted-pair connector to UTP/STP copper cable and an RX (receive) and TX (transmit) **SC 1300nm multimode** fiber connector.*

E-PSW-FX-03(SM)

*Provides an RJ-45 twisted-pair connector to UTP/STP copper cable and an RX (receive) and TX (transmit) **SC 1300nm singlemode** fiber connector.*

E-PSW-FX-03(LH)

*Provides an RJ-45 twisted-pair connector to UTP/STP copper cable and an RX (receive) and TX (transmit) **SC 1300nm singlemode** fiber connector.*

E-PSW-FX-03(XL)

*Provides an RJ-45 twisted-pair connector to UTP/STP copper cable and an RX (receive) and TX (transmit) **SC 1300nm singlemode** fiber connector.*

E-PSW-FX-03(LW)

*Provides an RJ-45 twisted-pair connector to UTP/STP copper cable and an RX (receive) and TX (transmit) **SC 1550nm singlemode** fiber connector.*

E-FL-HB-0x00 in the Network 2
Installation 4
Operation 11
Fault Isolation and Correction 12
Cable Specifications 13
Technical Specifications 15
Compliance Information 16

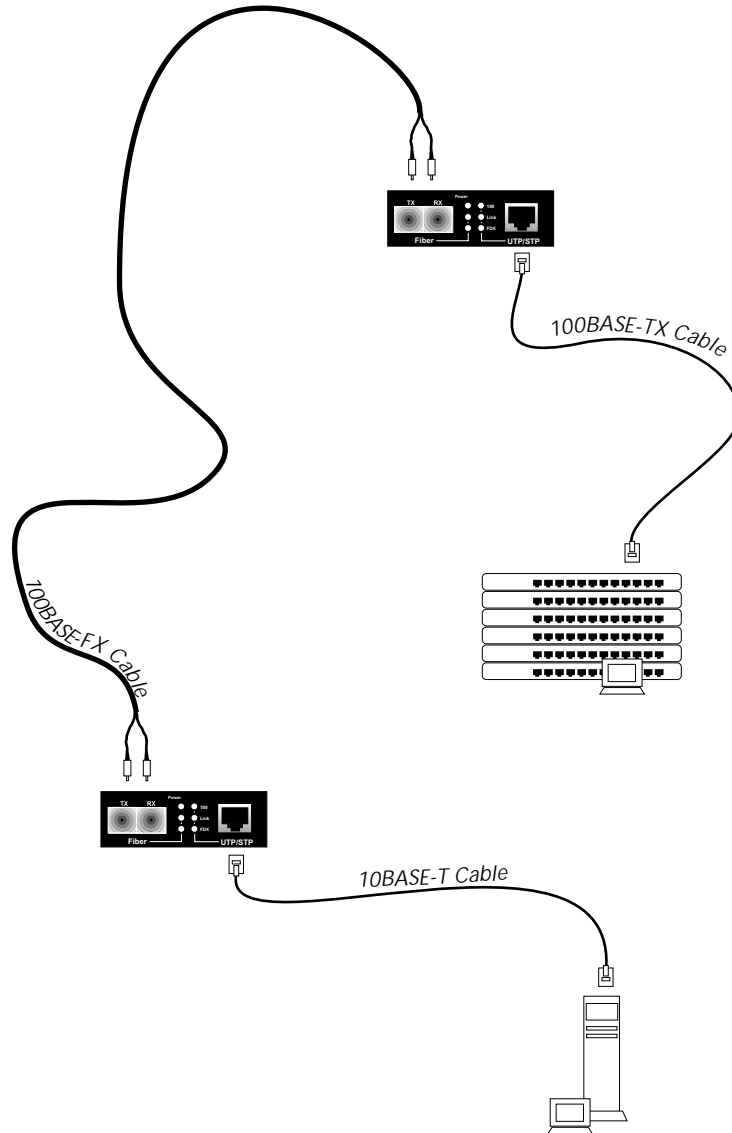

E-PSW-FX-03 IN THE NETWORK

The TRANSITION Networks E-PSW-FX-03 series two-port bridging media converter is intended to be installed, singly or in pairs, to provide network distance extension, network congestion reduction, and/or rate conversion between legacy Ethernet™ and Fast Ethernet devices.

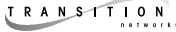

TECHNICAL SPECIFICATIONS

Standards	IEEE 802.3	
Case Dimensions	4.75" x 3.0" x 1.0"	(119mm x 76mm x 25mm)
Shipping Weight	2 pounds	(0.9 kilograms)
Environment	Temperature:	0-50°C (32° to 122° F)
	Storage Temperature:	-20 to 85°C
	Humidity	10-90%, non condensing
	Altitude	0-10,000 feet
Warranty	Lifetime	

	DECLARATION OF CONFORMITY
Name of Mfg: Transition Networks 6475 City West Parkway, Minneapolis MN 55344 USA	
Model: E-PSW-FX-03 Series Bridging Media Converter	
Part Number: E-PSW-FX-03, E-PSW-FX-03(SC), E-PSW-FX-03(SM), E-PSW-FX-03(LH), E-PSW-FX-03(LW), E-PSW-FX-03(XL)	
Regulation: EMC Directive 89/336/EEC	
Purpose: To declare that the <i>E-PSW-FX-03</i> to which this declaration refers is in conformity with the following standards.	
EMC-CISPR 22: 1985 Class A; EN 55022: 1988 Class A; EN 50082-1:1992; EN 60950 A4:1997; IEC 801.2, IEC 801.3, and IEC 801.4; IEC 950	
<i>I, the undersigned, hereby declare that the equipment specified above conforms to the above Directive(s) and Standard(s).</i>	
 Stephen Anderson, Vice-President of Engineering	September 10, 2000 Date

CABLE SPECIFICATIONS (continued)

The physical characteristics of the 100BASE-FX cable must meet or exceed IEEE 802.3 100BASE-FX specifications.

Fiber Cable

Bit error rate: $\leq 10^{-9}$

MULTIMODE

Fiber Optic Cable Recommended: 62.5 / 125 μm multimode fiber
Optional: 100 / 140 μm multimode fiber
85 / 125 μm multimode fiber
50 / 125 μm multimode fiber

E-PSW-FX-03

Fiber Optic Transmitter Power: min: -19.0 dBm max: -14.0 dBm

Fiber Optic Receiver Sensitivity: min: -30.0 dBm max: -14.0 dBm

Typical Maximum Cable Distance*: 2 kilometers

E-PSW-FX-03(SC) 1300 nm

Fiber Optic Transmitter Power: min: -19.0 dBm max: -14.0 dBm

Fiber Optic Receiver Sensitivity: min: -30.0 dBm max: -14.0 dBm

Typical Maximum Cable Distance*: 2 kilometers

SINGLEMODE

Fiber Optic Cable Recommended: 9 μm singlemode fiber

E-PSW-FX-03(SM) 1300 nm

Fiber-optic Transmitter Power: min: -15.0 dBm max: -8.0 dBm

Fiber-optic Receiver Sensitivity: min: -31.0 dBm max: -8.0 dBm

Typical Cable Distance*: 20 kilometers

E-PSW-FX-03(LH)** 1300 nm

Fiber-optic Transmitter Power: min: -8.0 dBm max: -2.0 dBm

Fiber-optic Receiver Sensitivity: min: -34.0 dBm max: -7.0 dBm

Minimum Attenuation: 8 dB

Typical Cable Distance*: 40 kilometers

E-PSW-FX-03(XL) 1300 nm

Fiber-optic Transmitter Power: min: -5.0 dBm max: 0.0 dBm

Fiber-optic Receiver Sensitivity: min: -34.0 dBm max: -7.0 dBm

Minimum Attenuation: 7 dB

Typical Cable Distance*: 60 kilometers

E-PSW-FX-03(LW) 1550 nm

Fiber-optic Transmitter Power: min: -5.0 dBm max: 0.0 dBm

Fiber-optic Receiver Sensitivity: min: -34.0 dBm max: -7.0 dBm

Spectral Width: 0.4 nm FWHM

Minimum Attenuation: 7 dB

Typical Cable Distance*: 80 kilometers

*Actual distance dependent upon physical characteristics of network installation.

**Minimum fiber cable loss MUST be 8.0 dB to prevent receiver damage.

Network Distance Extension

The TRANSITION Networks two-port Ethernet/Fast Ethernet bridging media converter can extend Fast Ethernet half-duplex network distances by separating one or two half-duplex Ethernet or Fast Ethernet copper CSMA/CD collision domain(s) by a half-duplex Fast Ethernet fiber CSMA/CD collision domain or by connecting two half-duplex or full-duplex Ethernet or Fast Ethernet copper CSMA/CD collision domain(s) over full-duplex fiber.

Network Congestion Reduction

The TRANSITION Networks two-port Ethernet/Fast Ethernet bridging media converter can reduce network congestion by segmenting network traffic. Network segmentation is achieved by regulating the number of data signals sent among stations. The bridging media converter scans the destination address on each packet header received on a port, searches a dynamic internal MAC routing table, and forwards the packet only if the data is intended for a station beyond the local collision domain. If the data is intended for a station on the collision domain from which the packet was received, the bridging media converter discards (filters) the packet, since any signal on the local segment already has been received by all stations on that segment. Baseline network performance also is improved because bridging media converters do not forward collision signals or error packets from one collision domain to another.

Rate Conversion

The TRANSITION Networks two-port Ethernet/Fast Ethernet bridging media converter can provide rate conversion between terminal devices on a 10BASE-T copper legacy Ethernet network and terminal devices on a 100BASE-FX fiber Fast Ethernet network, using the auto-negotiation process. When two auto-negotiating devices with multiple capabilities are connected together, the highest performance mode of operation is found based on a priority table. Each 100BASE-TX station sends a burst of link integrity test pulses, called a fast link pulse (FLP). If the receiving switch is capable of 10BASE-T communication only, the FLPs are ignored and the cable segment operates as 10BASE-T. If the device *can* support 100BASE-TX operation, the bridging media converter detects the FLPs, uses the auto-negotiation algorithm and FLP data to determine the highest possible cable segment speed and mode, and automatically places both the device and the bridging media converter into 100BASE-TX mode.

INSTALLATION

Setting DIP Switch

NOTE: Set DIP switch (located on Media Converter Slide-in-Module circuit board) BEFORE installing Media Converter Slide-in-Module in the Media Conversion Center.

DIP switch settings shown below are set to configure the bridging media converter for the site installation.

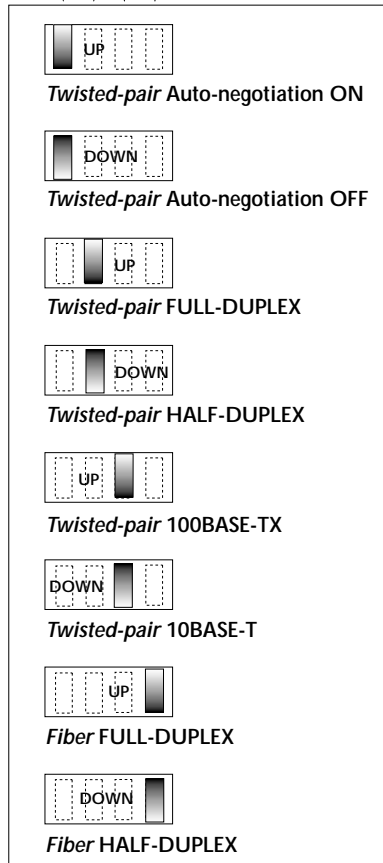

To set network speed(s) and operating mode(s), use a very small flatblade screwdriver or similar device and refer to the table at the left and to the examples on the next page to set DIP switch for the site installation.

NOTE: Auto-negotiation is designed so that a twisted-pair link will not become operational until matching capabilities exist in the devices installed at both ends of the 802.3u twisted-pair network.

- When auto-negotiation is enabled using switch #1, the bridging media converter “advertises” rate and mode capabilities to the network. Switch #2 and switch #3 are used selectively to set the twisted-pair rate and mode to be “advertised” OR to allow the full range of rates and modes.
- When auto-negotiation is disabled using switch #1, the bridging media converter does not “advertise” rate and mode capabilities to the network. Switch #2 and switch #3 are used to set twisted-pair rate and mode.

CABLE SPECIFICATIONS

Copper Cable Specifications

10BASE-T

The physical characteristics of 10BASE-T cable must meet or exceed IEEE 802.3 10BASE-T specifications. Though Category 3 cable is adequate for the 10BASE-T installation, Category 5 cable is strongly recommended, since Category 3 cable can not be used for a later upgrade to 100BASE-TX. DO NOT USE FLAT OR SILVER SATIN WIRE.

100BASE-TX

The physical characteristics of 100BASE-TX cable must meet or exceed IEEE 802.3 100BASE-TX specifications. Category 5 cable or better is required. Either shielded twisted pair (STP) or unshielded twisted pair (UTP) can be used. DO NOT USE FLAT OR SILVER SATIN WIRE.

Category 3:

Gauge 24 to 22 AWG
Attenuation 6.5 dB/100' @ 10 MHz
Differential Characteristic Impedance 100 Ω ±15%

Category 5:

Gauge 24 to 22 AWG
Attenuation 22 dB/100' @ 100 MHz
Differential Characteristic Impedance 100 Ω ±15%

Maximum Cable Distance:

100 meters (330 feet)

Twisted-pair Copper Straight-Through /Crossover Configurations

The two active pairs in a 10BASE-T or 100BASE-TX network are pins 1 & 2 and pins 3 & 6. Use only dedicated wire pairs (such as blue/white & white/blue, orange/white & white/orange) for the active pairs.

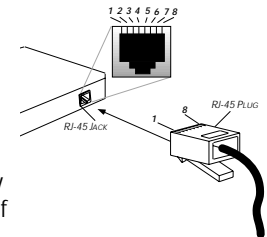

The two wires in each pair of the cable must be twisted together for the entire length of the segment and kept twisted to within approximately 1/2 inch of any connector to ensure the integrity of the signal-carrying characteristics of the unshielded wire pair.

Crossover Cable at RJ-45 Plug		Straight-Through Cable at RJ-45 Plug	
Bridging Media Converter RJ-45 Male	Network Device RJ-45 Male	Bridging Media Converter RJ-45 Male	Network Device RJ-45 Male
1 (TX+)	3	1 (TX+)	1
2 (TX-)	6	2 (TX-)	2
3 (RX+)	1	3 (RX+)	3
6 (RX-)	2	6 (RX-)	6

NOTE: Media converter is pinned as DTE device.

FAULT ISOLATION and CORRECTION

If a bridging media converter fails, ask the following questions and then taking the indicated action:

1. Is the P(o)W(e)R LED on the E-PSW-FX-03 illuminated?

NO

- Is the power adapter the proper type of voltage and cycle frequency for the AC outlet?
- Is the power adapter properly installed in the media converter and in the grounded AC outlet?
- Does the grounded AC outlet provide power?
- Contact Technical Support: (800) 260-1312.

YES

- Continue at step 2.

2. Is the Link LED illuminated on a port with twisted-pair installed?

NO

- Check UTP cables for proper connection/pin assignment.
- Ensure that terminal device(s) is/are powered.
- Disconnect and reconnect the copper cable to restart the initialization process.
- Restart the terminal device(s) to restart the initialization process.
- Contact Technical Support: (800) 260-1312.

YES

- Proceed to step 3.

3. Is the Link LED illuminated on a port with fiber installed?

NO

- Check fiber cables for proper connection.
- Verify that TX and RX cables are connected to RX and TX ports, respectively, on 100BASE-FX device.
- Ensure that terminal device(s) is/are powered.
- Disconnect and reconnect the fiber cable to restart the initialization process.
- Restart the terminal device(s) to restart the initialization process.
- Refer to Tech Tips available at: <http://www.transition.com>
- Contact Technical Support: (800) 260-1312.

YES

- Contact Technical Support: (800) 260-1312.

TWISTED-PAIR AUTO-NEGOTIATION:

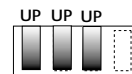

Set auto-negotiation (DIP switch #1) to select auto-negotiation: ON=UP

Set twisted-pair full-duplex/half-duplex (DIP switch #2) to select full-duplex: ON=UP

Set twisted-pair 10BASE-T/100BASE-TX (DIP switch #3) to select 100BASE-TX: ON=UP

TWISTED-PAIR FULL-DUPLEX 100BASE-TX:

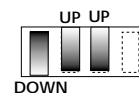

Set auto-negotiation (DIP switch #1) to de-select auto-negotiation: OFF=DOWN

Set twisted-pair full-duplex/half-duplex (DIP switch #2) to select full-duplex: ON=UP

Set twisted-pair 10BASE-T/100BASE-TX (DIP switch #3) to select 100BASE-TX: ON=UP

TWISTED-PAIR 10BASE-T WITH MODE AUTO-NEGOTIATION:

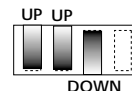

Set auto-negotiation (DIP switch #1) to select auto-negotiation: ON=UP

Set twisted-pair full-duplex/half-duplex (DIP switch #2) to select full-duplex: ON=UP

Set twisted-pair 10BASE-T/100BASE-TX (DIP switch #3) to select 10BASE-T: OFF=DOWN

FIBER FULL-DUPLEX 100BASE-FX:

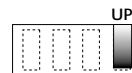

Set fiber full-duplex/half-duplex (DIP switch #4) to select full-duplex: ON=UP

FIBER HALF-DUPLEX 100BASE-FX:

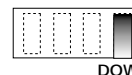

Set fiber full-duplex/half-duplex (DIP switch #4) to select half-duplex: OFF=DOWN

INSTALLATION (continued)

Using the 5-Segment Rule (10BASE-T)

The Ethernet 10BASE-T 5-segment rule defines a segment as the cable connection between station interfaces. The transmission path between any two terminal devices **in the same collision domain** can consist of no more than five segments. Installing the Transition Networks' bridging media converter in the network separates collision domains, so the 10BASE-T 5-segment rule applies **separately to each collision domain**.

To assign segment numbers to cable connections:

1. Determine the network device separated from the Transition Networks' pocket switch by the greatest number of segments.
2. Define a segment path between that network device and the Transition Networks' pocket switch by labeling the cable connection to the Transition Networks' pocket switch "segment 1" and numbering each segment in the path to the terminal up to "segment n" (n = total number of segments + 5).
3. Verify that no segment path in the collision domain contains more than n + 5 segments.
4. Repeat steps 1-3 for next collision domain.

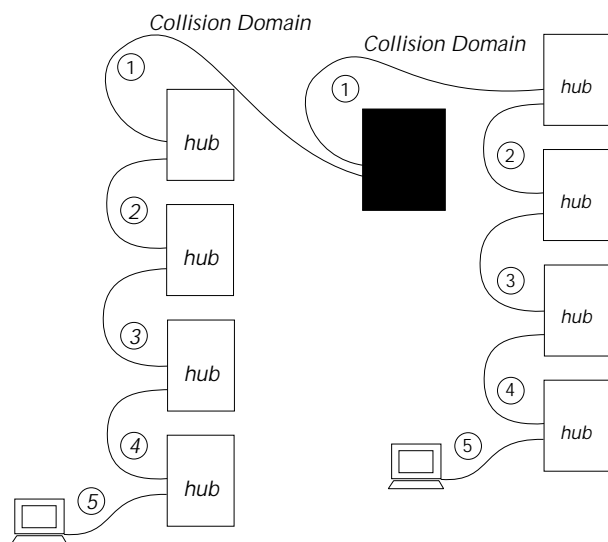

OPERATION

Use the status indicator LEDs to monitor E-PSW-FX-03 operation in the network.

STATUS LEDs

Power

Steady green LED indicates connection to external AC power.

100

Indicates 100MB/s mode on UTP/STP.

Link

(RECEIVE) Steady green LED indicates UTP/STP OR Fiber link.

Blinking green LED indicates packet reception on UTP/STP OR on Fiber link.

FDX

Steady green LED indicates full-duplex operation on UTP/STP OR on Fiber link.

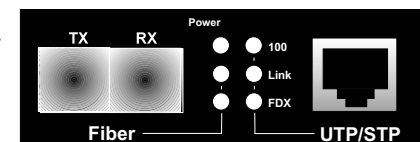

INSTALLATION (continued)

Powering the Bridging Media Converter

To power ON the bridging media converter:

1. Locate power receptacle on back of bridging media converter
2. Connect the bridging media converter power connector end of the power supply adapter to the power receptacle on the back of the Transition Network's bridging media converter.
3. Connect the external power connector end of the power supply adapter to external AC power.

NOTE: After the power supply adapter is connected to the bridging media converter and to external power, the green **Power** LED is illuminated.

Using the 512-Bit Rule (100BASE-TX/100BASE-FX)

A bit-time (BT) is the amount of time required to send one data bit across an Ethernet LAN. The total number of bit-times between any two DTEs in the same Fast Ethernet 100BASE-TX or 100BASE-FX collision domain cannot exceed 512 bit-times in the round trip.

To calculate the round trip delay in bit-times between a station (DTE) and the Transition Networks' bridging media converter, determine the Fast Ethernet worst case round-trip delays expressed in bit times:

- Find the longest and most complicated collision domain path between the station and the Transition Networks' Bridging Media Converter.

Class I Repeater140 BT
Class II Repeater92 BT
Class I TX/FX Media Converter130 BT
Class II TX/FX Media Converter92 BT
DTE50 BT
1 meter of CAT.5 TP cable1.11 BT
1 meter of fiber cable1 BT
Bridging Media Converter50 BT

- Calculate the round trip delay for each cable segment by multiplying the length of the cable (in meters) by the delay per meter (in bit times (BT)) for each cable type as listed in the table
- Calculate the total round trip delay by taking the sum of all the individual cable delay values in the path, as listed in the table, plus station (DTE) delays and hub (repeater) delays.
- Add the segment delay values together. If the result is less than or equal to 512 bit times, the path passes the test.

NOTE: *Actual manufacturers' bit-time values and/or measured bit-time values may be greater or less than bit-time values listed in the chart.*

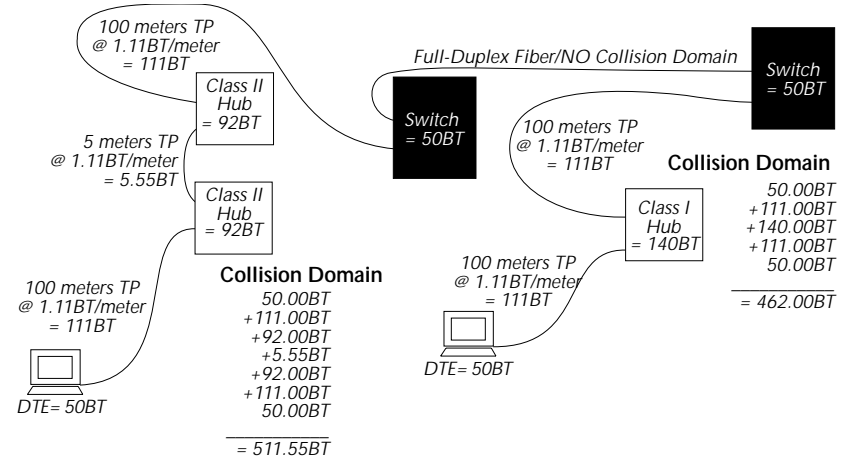

INSTALLATION (continued)

Connecting Copper Cable (10BASE-T/100BASE-TX)

Ensure that the correct cable type is installed to support the highest speed and mode of operation to be selected. Though Category 3 cable is adequate for the 10BASE-T installation, Category 5 cable is strongly recommended, since Category 3 cable can NOT be used for 100BASE-TX.

10BASE-T AND THE ETHERNET COLLISION DOMAIN

- Refer to the 5-Segment Rule (page 8) before installing **half-duplex** 10BASE-T cable.
- Installing **full-duplex** twisted-pair cable avoids collision domain considerations; distances remain ≤ 100 meters.

100BASE-TX AND THE FAST ETHERNET COLLISION DOMAIN

- Refer to the 512-Bit Rule before installing **half-duplex** 100BASE-TX cable.
- Installing **full-duplex** twisted-pair cable avoids collision domain considerations; distances remain ≤ 100 meters.
- NOTE: A Fast Ethernet collision domain can have **ONLY ONE** CLASS I repeater OR **TWO** CLASS II repeaters.

INSTALLING CABLE

To install 10BASE-T or 100BASE-TX cable:

1. Locate or build 10BASE-T or 100BASE-TX cables:
 - 803.2 (10BASE-T) or 803.2u (100BASE-TX) compliant
 - with *Straight-through or Crossover* RJ-45 cable/connectors as required for site installation (page 13)
 - with RJ-45 plug connectors installed at both cable ends.
2. Connect RJ-45 plug connector at one end of 10BASE-T or 100BASE-TX cable to bridging media converter RJ-45 jack connector.
3. Connect RJ-45 plug connector at other end of 10BASE-T or 100BASE-TX cable to RJ-45 jack connector on network device..

100BASE-FX Full-Duplex Optical Loss Budget

An 11dB loss budget (measured using a fiber optic power meter) is allowed per link of 100BASE-FX Full-Duplex cable. Standard grade fiber operating at 1350 nm has approximately 1dB – 2dB loss per 1000 meters of cable. Approximately 0.5dB– 2.0dB loss per connection point is typical, depending on the integrity of the connection.

Connecting Fiber Cable (100BASE-FX)

100BASE-FX AND THE FAST ETHERNET COLLISION DOMAIN

- Refer to the 512-Bit Rule before installing **half-duplex** 100BASE-FX cable (≤ 415 meters).
- Using **full-duplex** fiber cable avoids collision domain considerations and extends distances up to 2 kilometers (multimode) or up to 20 kilometers (singlemode).
- NOTE: A Fast Ethernet collision domain can have **ONLY ONE** CLASS I repeater OR **TWO** CLASS II repeaters.

INSTALLING CABLE

To install 100BASE-FX cable:

1. Locate or build 100BASE-FX cables:
 - 803.2u compliant
 - with male transmit (TX) and receive (RX) fiber connectors installed at both cable ends.
2. Connect transmit cable connector at one end of fiber cable to bridging media converter connector marked with an "outbound" arrow; connect receive cable connector to bridging media converter connector marked with an "inbound" arrow.
3. Connect other end of cable installed at transmit (TX) connector of bridging media converter to receive (RX) connector on network device; connect other end of cable installed at receive (RX) connector of bridging media converter to transmit (TX) connector on network device.
